

The Coventry Cat



Official Newsletter of the Jaguar Association of New England

April 2016

www.j-a-n-e.org



Ahhmelia!

Jaguar had a wonderful presence at the 2016 Amelia Island Concours d'Elegance once again with a new F-Type on their display platform. Other classic Cats represented were the SS100 and an XK150S in what appears to be Cotswold Blue. Photos courtesy Ivy Cowles.



PARTS & ACCESSORIES
FOR
CLASSIC & MODERN
JAGUARS

www.sngbarratt.com

COVERING ALL MODELS 1949 - CURRENT

EXPERIENCE & KNOWLEDGE

BRANCHES WORLDWIDE

PARTS FINDER & EASY ONLINE ORDERING

IN-HOUSE MANUFACTURING

FREE* PARTS CATALOGUES

*registration required



+44 (0) 1746 765432



+1 800 452 4787



+33 385 201420



+31 13 521 1552



018 01 833 833 (GERMANY ONLY)



Spring into the Driving Season

The British Beer Company in Walpole, Massachusetts, was the venue for our March monthly meeting, which joins the growing list of other successful club events. The room was ideal for the Rust Brothers to present their adventures on accumulating extensive new and used vintage Jaguar parts while club members enjoyed beer on tap from our own private bar, with two bartenders and a warm meal. We also had the opportunity to catch up with several club members who aren't normally at the other monthly meet-

ings, while collecting some nice beer glasses courtesy of Fuller's Distributing and the British Beer Company.

By the time this goes to press and you will be able to read this, our club delegates will have traveled to the JCNA AGM and the first ever International Jaguar Festival in Scottsdale, Arizona. This will be an opportunity to enjoy some warm weather, local cuisine, and a few pretty dry meetings, as well as see how West Coast or Southwest cars compare to the ones we see here in New England, and how the judging will compare. There should be plenty of pictures for the next issue of the Cat as well.

Coming up right after the AGM, Bruce Whitmore will be taking us on our annual Tour to Parker's Maple Barn on Sunday, April 10th. For any of you who haven't taken advantage of this event in previous years, Parker's is one of the best places around to end up for pancakes, waffles, and anything else you might want to put fresh maple syrup on. This is a dining experience not to be missed, so if you haven't signed up yet, make sure you go to the website and reserve your place at the event, or you may end up eating in the far corner of the barn.

Our racing members will be heading back to the track toward the end of the month, as both Lime Rock and Thompson will be having SCDA track days. This will provide several opportunities for members to go out and support their favorite race driver and fellow member while living semi-vicariously through them as they round the corners and fly down the straight-aways. Oh, what fun to go racing for a day in a vintage sports car!

Our April monthly meeting will be back at the Wayside Inn with a presentation of Adventures in a DIY restoration by Eric Kriss. If you weren't able to make the tech session in early March, you should make plans to attend this presentation and see what a fabulous job Eric has done in restoring his 1961 2.4 Mark 2 from top to bottom. There are also a few modern upgrades that have been tastefully integrated alongside the 1960's technology. We might even get a chance to see the car if it makes it back from the paint shop in time. Also look for Bruce Murray to add a segment on his upgraded heater for the Mark 2.

May is also quickly approaching, with some more top events, including our annual Judge's Training session and the Cars on the Lawn at Larz Anderson. The May monthly meeting at Larz holds the club record for attendance for the last five years, and providing the weather is good we might even break a 100 members this year. Make sure that you register early for this meeting so that you don't miss out.

The Concours preparation is well under way with Jane Murray at the helm, but there is still plenty to accomplish. We are still looking for several volunteers to take on some openings for that weekend, including Hospitality, Silent Auction, and Raffle. This is a good way to help the club and get to know some of your fellow members better, and who knows, there might even be a few welcome benefits included. If you do business with someone you think has a product or service that other members might want to use, please consider asking them to

continued on next page

The Coventry Cat is the official publication of the Jaguar Association of New England (JANE), a non-profit organization of Jaguar enthusiasts that is a regional chapter of the national Jaguar Clubs of North America (JCNA). JANE is incorporated in the Commonwealth of Massachusetts.

JANE Officers & Committee Chairs

- President:** Jim Sambold, 603-918-8795, xkjagnut@comcast.net
- VP Events:** Dean Saluti, 617-285-6565, djsaluti@aol.com
- VP Membership:** Howard Kalet, 508-380-7898, kaletfamily@comcast.net
- Secretary:** Bonnie Getz, 603-943-6400, nhbonnie@gmail.com
- Treasurer:** Don Holden, 603-673-8167, donholden@rcn.com
- Concours:** Jane Murray, 781-729-1886, mszahna@hotmail.com
- Head Judge:** Jim Sambold, 603-918-8795, xkjagnut@comcast.net
- Slalom:** Richard Kosinski, 978-685-4111, richardkosinski@comcast.net
- Webmaster:** Dennis Eklof, 508-878-9510, dennis.eklof@verizon.net
- Traveler Contact:** Gary Hagopian, 603-763-3093, g.hagopian38@gmail.com

Board Members

- Michael Kaleel • John Brady • Jane Murray • Marjorie Cahn
- Dennis Eklof • Frank Grimaldi • Rich Kosinski
- Lauren MacCarthy • David Moulton • Jennifer Taylor
- Gus Niewenhaus • Mike Axford • Aldo Cipriano

The Coventry Cat

- Editor:** Tracey Levasseur, 207-247-3385, sharpei@sacoriver.net
- Assistant Editor:** Prebble Eklof, 617-877-5825, prebble.eklof@verizon.net
- Circulation:** Barbara McLachlan, 508-947-0313, bamclachlan@verizon.net
- Send articles, info, and photos to:** sharpei@sacoriver.net -or- The Coventry Cat, 329 Ross Corner Rd, Shapleigh, ME 04076
- Advertising:** Carl Hanson, 781-275-2707, chansonjag@aol.com

Display Advertising Rates

An ad in *The Coventry Cat* currently reaches over 350 households with excellent demographics. Rates are on an annual basis (12 issues):

Business Card (Members)	\$60
(Non-members)	\$120
Quarter page	\$175
Half page	\$325
Full page	\$600
Inside back cover	\$1200
Inside front cover	\$1000
Back cover half page	\$500

Visit JANE on the web at www.j-a-n-e.org

JANE is also on facebook at www.facebook.com/JagsNEWall

President's Message continued

support our Silent Auction or Raffle. They may even get their next customer from giving a small donation to our Concours.

JANE has been and continues to be one of the most successful Jaguar clubs in JCNA. This has happened only through the hard work and dedication of volunteering and generosity from its members for many years. We are all very proud of the achievements that have been made, as this is your club and you get out only what you put in, so please consider stepping up, as every little bit helps make it that much more of a success for everyone.

I look forward to seeing many more of you at the coming events!

Jim

JANE Car Badges Are Almost Gone!

The 100 JANE car/grille badges that were ordered last year are almost gone. It may be quite some time before any more are ordered, so if you would like one, you should contact Ed Avis (eavis46015@roadrunner.com / 207-737-8258) or Howard Kalet (ryejag@comcast.net / 508-380-7898) SOON before they're all gone! Badges are \$45 each.

IF YOU PAID FOR A BADGE AND HAVE NOT YET RECEIVED IT, PLEASE CONTACT ED AVIS ASAP SO WE'LL HAVE A FINAL COUNT OF HOW MANY MORE WE CAN SELL!



603 (&USA 800) 424-3820
Fax 603-424-0900
e-mail: aew@autoelectric.com

AUTO ELECTRIC WAREHOUSE, INC.
Starters, Alternators & Batteries
OUR DIFFERENCE IS EXCELLENCE

DANA J. MERRILL
PRESIDENT

8A Griffin Street
PO Box 1208
Merrimack, NH 03054-1208



JANE Membership as of March 26 is now up to 269 after four new members have joined, a number of late renewals, plus a member relocating across the pond to the UK! This compares quite favorably to last year when JANE reached 253 members by the end of February. We are well on our way to my goal of 300 members for the year! I will be very proud to share our latest JANE strong membership levels at the AGM meeting in Scottsdale.

Please encourage any of your friends who have any interest in JANE to attend an upcoming event as a guest. The JANE website is a great place for prospective members to sign in with a guest membership and see the full calendar of activities held year round. Brochures are also available at our meetings.

I am looking forward to upcoming events for our Cats including May 25 at the Larz Anderson picnic and the June 2-5 Quebec City trip. If I heard correctly there are presently 69 members signed up for the

Quebec trip.

Looking for JANE car badges? Ed Avis had given me the final few badges and they are available for \$45. If you have any interest, purchase yours today, once they are gone it may be awhile before we order any new ones.

Cheers,

Howard Kalet

Welcome New Members

Gary Gammans, Michael Spring	Keene, NH	1953 Mk VII
Harold Jordan	Bow, NH	1967 XKE, FHC
Eric Kriss	Newton, MA	1961 Mark 2
Robert & Deborah Barris	Saco, ME	

...And Former Members Who Rejoined

Todd Stuart	Cambridge, MA	1986 XJS Coupe, 2001 XKR Convertible,
		1988 XJS Cabriolet
Graham & Joyce Briggs	Needham, MA	1998 XK8 Convertible

Upcoming Events

2016 JANE Events Calendar

You may register for any JANE event online at www.j-a-n-e.org and pay in advance by credit card or PayPal

Date	Event	Location
April 10	JANE Maple Tour & Luncheon	Parker's Maple Barn, Mason, NH
April 27	JANE Monthly Meeting – Speaker Eric Kriss	Wayside Inn, Sudbury, MA
May 15	JANE Concours Judges Training Session	TBA
May 25	JANE Monthly Meeting – Speaker John Elmgreen	LAAM, Brookline, MA
June 2-6	JANE Tour to Quebec City	Quebec, Canada
June 9-12	2nd Annual Bristol British Motorcar Festival	Bristol, RI
June 12	JCSNE Annual Concours	Middlefield, CT
June 18	JANE Spring Slalom	North Andover, MA
June 22	JANE Monthly Meeting	Inn at Bay Pointe, Quincy, MA
June 26	British Car Day on the Lawn at Larz Anderson	LAAM, Brookline, MA
July 24	JANE at Myopia Polo Club Match	South Hamilton, MA
July 27	JANE Monthly Meeting	Wayside Inn, Sudbury, MA
August 12-14	JANE Annual Concours	Sturbridge Host Hotel, Sturbridge, MA
August 20	JANE Potluck Picnic and Lawn Party	TBA
September 10	JANE Autumn Slalom	North Andover, MA
September 16-18	26th Annual British Invasion	Stowe, VT
September 18	5th Annual Boston Cup	Boston, MA
September 28	JANE Monthly Meeting	Wayside Inn, Sudbury, MA
October 1	JANE Lobster Tour in Maine	TBA
October 21-23	JANE Martha's Vineyard Weekend	Martha's Vineyard
October 26	JANE Monthly Meeting	Wayside Inn, Sudbury, MA
November 16	JANE Monthly Meeting	Wayside Inn, Sudbury, MA
December 4	JANE Holiday Party and AGM	Vesper Country Club, Tyngsboro, MA

MOSTLY BRITISH



FOREIGN AUTOMOTIVE SPECIALIST
IN REPAIR, RESTORATION, USED, NEW & NOS PARTS

FREDERICK J. PETROSKE

12101 NYS RT 12E ■ P O Box 438 ■ Chaumont, NY 13622
315-649-2861 ■ FAX: 315-649-4100
E-Mail: petroske@tds.net ■ www.mostlybritish.com

Upton Foreign Motors

Quality Jaguar Service and Repair
Factory Trained Master Jaguar Mechanic
Guaranteed to Best Dealer Labor Rates

Dana Schwehr, Owner
138 Milford Street (Rt.140)
Upton, MA 01568
(508) 529-4040
www.uptonforeignmotors.com



Upcoming Events

April Monthly Meeting Wednesday, April 27, 7pm

Longfellow's Wayside Inn, Sudbury, Massachusetts

Guest speaker Eric Kriss - Adventures in DIY Restoration

Because of the fine job that Eric did at our recent tech session in his garage, he has been asked to speak at our April dinner meeting. Many of us were given the opportunity to see the progress on his Mark 2. Bruce Murray has agreed to assist Eric by introducing the custom heating system that he designed specifically for Eric's car.

In March 2014 Eric purchased a 1961 Jaguar Mark 2 that had been garaged in Weston, Massachusetts, for eighteen years. The car ran reasonably well, but *everything* needed work, from the soiled headliner down to the rusted-out jacking tubes on the undercarriage. During the last twenty-four months, Eric completely disassembled the car -- every nut, bolt, and piece of tar off -- and then reassembled it. Now the Jaguar is running again, awaiting a new interior that will be installed this spring. There have been many twists and turns along the way, and Eric will describe some of his adventures. Great fun for those in the middle of their own restoration, or anyone dreaming of what to do with that wonderful old classic waiting patiently in the garage for decades. Follow the car's progress at Eric's popular blog <http://fairislepress.com/WP/>.



May Monthly Meeting Wednesday, May 25, 7pm

Larz Anderson Auto Museum
15 Newton St
Brookline, MA 02445

Guest speaker John Elmgreen



John Elmgreen is an Australian-born and resident Jaguar XK motoring historian and co-author of *The Jaguar XK in Australia* (1985) and *The Jaguar XK120 in the Southern Hemisphere* (2010) (www.jtpublications.com.au). He has researched the histories of individual Jaguar XKs since about the time he bought his first XK in 1969, starting in Australia, and since the mid-1990s on a worldwide basis, when he started the XK email group XK-Lovers. He is a member of the Society of Automotive Historians (USA), the Classic Jaguar Association (USA), for which he is the XK120 Registrar, the Jaguar Drivers' Club of Australia, the Jaguar Car Club of Victoria (Australia), the Jaguar Enthusiasts' Club (UK), the XK Club (UK), the Jaguar Drivers' Club (UK), the Jaguar Association of New England (USA), and Jaguar Clubs of North America (USA). He has practiced as an attorney since the early 1970s, apart from six years living in London, and lives in Sydney with his wife, Frances.

So if John can travel from the other side of the world to attend a JANE meeting, there is no excuse for the rest of us!

JANE Tour to Quebec City – June 2016

Time marches on and it's time for another update on the Quebec City trip! Planning for the event is going well and all required deposits to the hotel, to Montmorency Falls, etc., have been made.

If you are considering this trip and have not yet signed up, we recommend that you decide VERY SOON. The trip is approaching the maximum number of people we can handle, and we are asking for final headcounts for events. We're preparing a survey to send to everyone who's already registered so we can notify the hotel and restaurant of menu preferences, let the folks at Montmorency Falls know how many to expect for the zip line, how many want to take the Friday/Sunday walking tours, etc. If you wish to join the trip or have questions, please call Mark (617-515-8050) or Ed (207-737-8258) so we can personally handle adding you to the activities.

If you plan to join the group driving up from Waterville, Maine, on the morning of June 2 and wish to spend the night of June 1 there before the rally, please make your reservations NOW at the Fireside Inn & Suites in Waterville. Call the hotel (207-873-3335) directly. Tell them you are with the Jaguar Association of New England for our group rate of \$74.46. June 2-5 is also Reunion Weekend at nearby Colby College and all rooms in the area will soon be booked!

Don't forget:

- Check your passport expiration date!
- Cell phone roaming charges can be very expensive - check your plan to see about roaming charges in Canada.
- No special electrical adaptors are needed (standard U.S. configuration).
- If you have any Canadian currency you may want to bring it along. If not, you may want to bring some small U.S. bills for tips for hotel staff upon arrival. An ATM is conveniently located diagonally across the street from the hotel and is probably the best way to get Canadian currency once we arrive.
- Plan to have a LOT of fun!

-- Mark and Ed

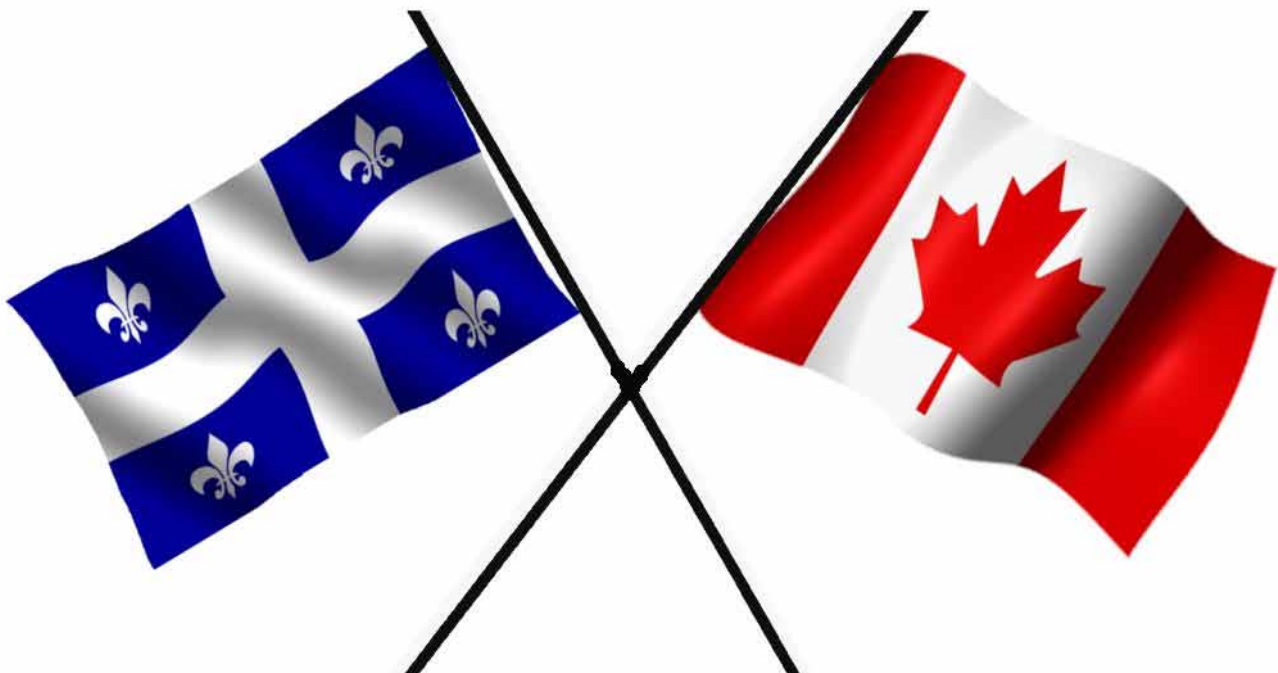

JANE's Concours d'Elegance and Jaguar Festival Sturbridge Host Hotel, Sturbridge, Massachusetts August 12–14, 2016

We're only four months out from JANE's 2016 Concours d'Elegance and Jaguar Festival, so isn't it time to start planning your Concours weekend now?

It's fun to kick off the weekend by arriving at the Sturbridge Host Hotel on Friday afternoon. Check in, settle in, then meet your fellow JANE members for a casual evening of socializing in the hospitality suite. There will be a pizza party that evening, with plenty of beer and wine for all, DVD's to watch, goodie bags to stuff for all the registrants, and a chance to reconnect and swap stories with Concours participants you may not have seen in a while.

Saturday is a full day, beginning with the beautiful Jaguars driving onto the show field in the morning and the meticulous detailing of the cars going on until "rags down" at noon, when the judging begins. Our DJ will be playing music all day. There will be dealer and vendor displays on the field, along with a display of JANE regalia. The raffle items will be displayed in the gazebo on the show field and the silent auction items will be set up in the hospitality suite. The winners of the raffle and silent auction items will be announced mid-afternoon as the judging is winding up. Then there will be cocktails, awards, and dinner under the tent, followed by more schmoozing in the hospitality suite in the evening. And the event will conclude with the usual Poker Run Sunday morning.

Here's Your Before-the-Event To-Do List

- Make your reservations for the weekend at the Sturbridge Host Hotel in Sturbridge, Massachusetts. Call the hotel direct at 508-347-7393, and ask for the JANE special group rate of \$127. If you prefer to make your reservation online, use the code 1608jaguar to get the special group rate. Don't wait, do it now!
- Register for the Concours on the JANE website. Enter your Jaguar for judging, or merely for display. If you don't want to enter your Jag in the competition, just come on out for the camaraderie of the weekend
- Plan to contribute a food item or two for the hospitality suite for the weekend.
- Donate some items for the raffle and silent auction. Car-oriented things are good, but non-car-oriented things are popular also. Call or email Prebble Eklof and let her know what you can donate, and we'll make arrangements to collect your item(s). prebble.eklof@verizon.net or 617-877-5825.

It takes the contributions of a lot of people to make this fun event the success it has always been. So now think about what you can do to help once you arrive for the weekend. Here are just a few suggestions for Saturday.

- Hand out registration packets and goodie bags as the cars queue up to enter the field.
- Direct the cars from that entry point to the photo set-up area, and then to their places on the show field.
- Help set up the raffle and silent auction displays.
- Sell raffle tickets.
- Collect and deliver the judges' scoring sheets from the field to the scoring team.

Check out the full schedule for the event on the JANE website, or contact our Concours Chair, Jane Murray, at mszahna@hotmail.com or 781-729-1886, to volunteer to help or to ask any questions you may have.



Mark 2 Restoration Tech Session



By Tracey Levasseur

For some car lovers, acquiring a classic vehicle starts with saving a chunk of change, searching and scrutinizing every Internet site and Want Advertiser (and maybe an auction or two), and finally, with luck, taking delivery of a roadworthy, finished beauty. And then there are those adventurous types....

Eric Kriss is the latter. He preferred a challenge: take a 1961 Mark 2 and do a complete restoration, document each level of progress, then invite some like-minded folks to visit the work in process to share his experiences.

And so on March 12, a group of about 15 JANE members were treated to Eric's project. Attendants got to see the Mark 2 in a state of restoration usually seen only by DIYers and those who do it for a living. The primed body lay in state on the car lift free of all interior bits and glass. Tables, boxes, shelves, and zip-top baggies hold all manner of hardware, wood trim, and other parts identified by tags. Ordered chaos. Eric has meticulously identified and tagged every piece during disassembly to make reassembly much easier. He even created a database to keep track of all the pieces. When dealing with hundreds of parts, organization and taking many photos are essential.

Another way Eric has kept track of his project is with his blog, <http://fairislepress.com/wp/>. Here he keeps a "diary" of what he's done, with photos and step-by-step instructions for all the world to see. The blog is also a way to get advice and other handy tips from followers who've "been there, done that."



Eric begins his talk with a brief history of what set this project in motion. He "reinvents the classic car," as his website states, by taking an old car or kit car and converting it to an electric car. In fact, one of his finished projects is a Saab Sonett electric conversion, which was at his shop during our visit. This was to be the fate of his Mark 2 until he met JANE's own Bruce Murray, who talked him out of yanking the 2.4 engine and manual gearbox and persuaded him to restore the car.



Even though Bruce saved Eric's car from some extreme modifications, Eric insisted on some more modern creature comforts. Among them are a conversion from the original two fuses controlling all the electronics to a modern multi-fuse system, updated front brakes, and a high-tech stereo control center with integrated back-up camera.

Those who own a Mark 2 know the original heater system is anything but hot. Eric realized this and went to Bruce for advice. Bruce came up with a modified heater assembly featuring a larger fan,

more powerful motor, and arched vanes within the assembly that all work together to move warmer air more efficiently into the car. He originally installed one in his own Mark 2 with positive results, so he made another for Eric. For details on this modified heater assembly see page 12.

Eric shared his accomplishments candidly, explaining the easy as well as the more challenging tasks. Bruce helped him with many of these and others, he admits, and he wished Bruce or another pair of hands was around. A combination of original, corroded parts and body panel fitment issues made otherwise simple repairs time-consuming efforts.

The talk concluded with starting the car, inspecting the engine bay, observing the underside work completed, and various questions answered about tasks still to be done. Before leaving, some attendees gathered around the electric Saab Sonett. From the outside the Sonett looks normal, but under the bonnet the gas engine is replaced with an AC50 electric motor and 18 lithium batteries. When started, the car is completely silent, and there is only a low whirring sound when it's moving. The car is beautiful and tastefully restored, just as the Mark 2 will be when finished.



Jim Sambold photo



Tracey Levasseur photo



Jim Sambold photo

Opposite page top: the 2.4 grille badge on Eric's car. Middle: The crowd gathers to observe and admire Eric's work in progress. Bottom: The back-up camera discreetly positioned just under the rear bumper. Photos by Jim Sambold.

This page clockwise from above: Stripped of all essential interior bits, Eric painted the exposed metal. Note the upgraded stereo above the shift. Eric's electric Saab Sonett. Under the Sonett's hood are 18 lithium batteries. Instead of a gas filler, the Saab has a plug. After an informative morning some members ventured to a local pub to socialize.



Bonnie Getz photo



Jim Sambold photo

Mark 2 Heater Improvements

Words and renderings by Bruce Murray

At a recent JANE tech session on a DIY restoration by Eric Kriss, Bruce Murray described the design, testing, and build of an improved heater fitted to Eric's Mark 2. This was designed to improve the performance of the original Jaguar design. The main features are a larger fan with a high-power motor, airflow control to use the whole of the heater matrix, a modern heater control valve, and modification of the under-dash interior ducting to improve the air distribution in the car. The motor speed is controlled with a pulse-width-modulated system that is more efficient than a simple series resistor, particularly important with the use of a high-power motor. A series choke is used to reduce the AC component of the current that causes unnecessary heating of the motor.

GENERAL VIEW HEATER ASSEMBLY

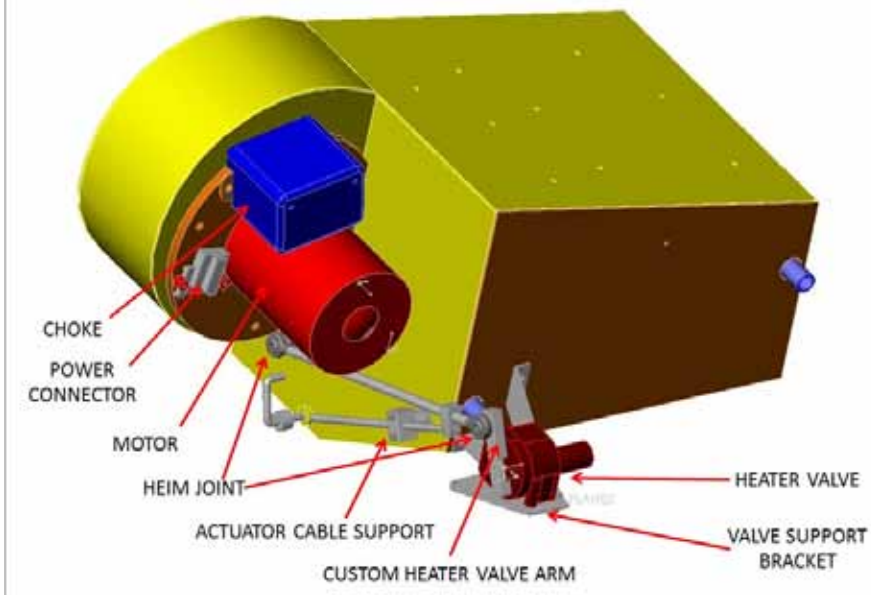

The outside view (left) showing new heater valve and linkage. This has been altered to provide more precise control and coordination of the valve and the flap positions.

View with the front cover removed (right), showing motor, choke, and turning vanes that distribute the airflow across the matrix more evenly than originally.

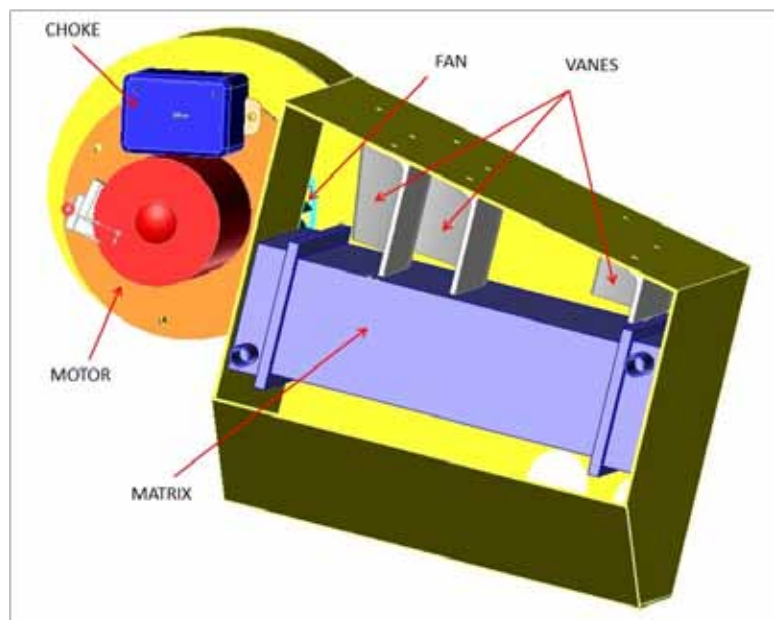

This is the heater installed in Bruce's Mark 2 (air filter removed for clarity). The heater seems to work well now and generates a comfortable level of flow and heat to the front seat occupants. Heat is not fed directly to the rear seats, since to do so significantly compromises the front heat. The demist performance has not been tested in fogging conditions, but is expected to be superior to the original even though it is constrained by the very small ducts at the base of the screen.

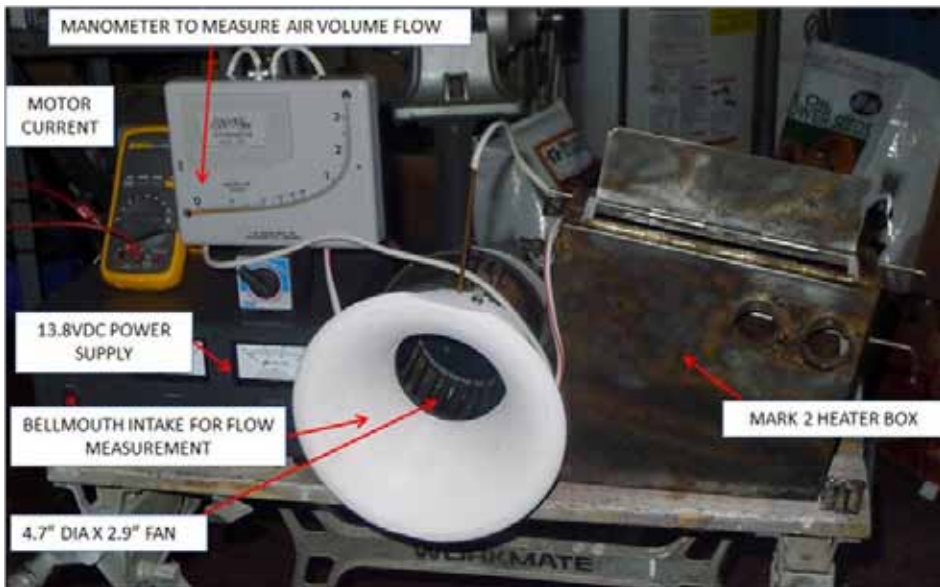
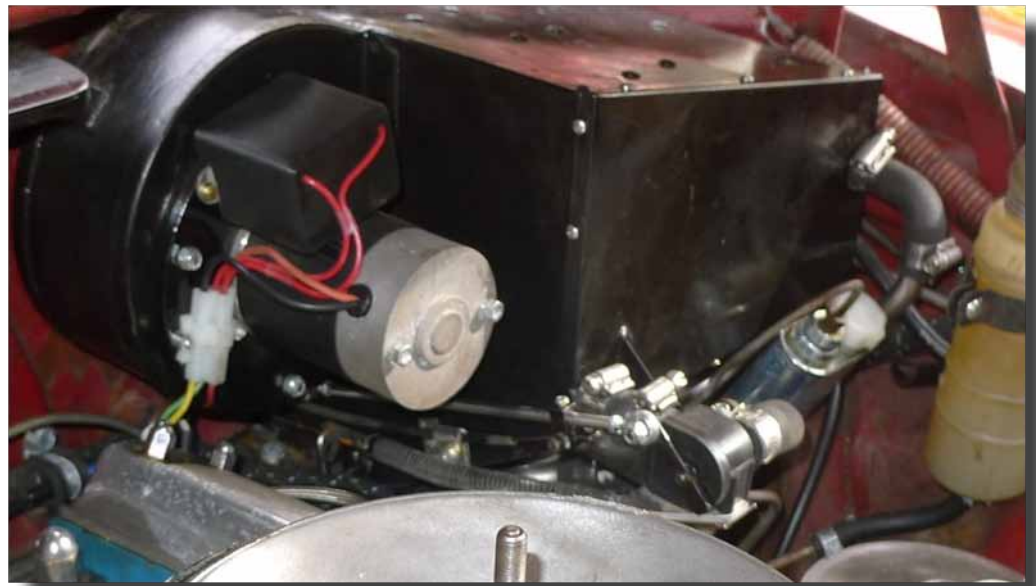

Left and below: And finally, to show that the heater was developed by testing (with just a little theory!), here are two pictures of the test rig and its instrumentation. Not shown is the airflow measurement probe, a Model 470-1 made by Dwyer Instruments, used to map the airflow distribution in the matrix area.

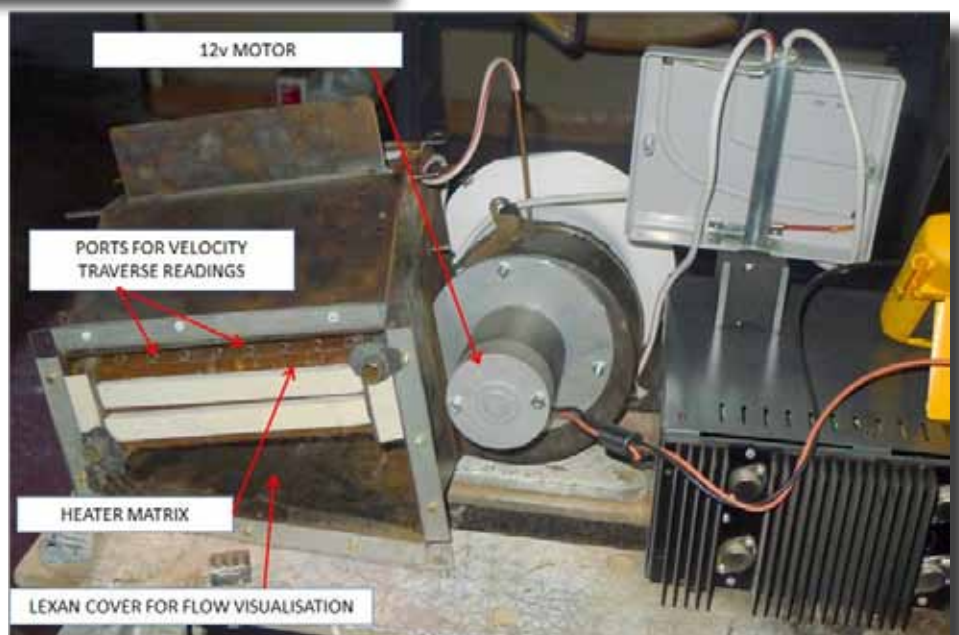



- Restoring XK model Jaguars for 40 years.
- Finest upholstery available.
- Our mail order upholstery kits have all the parts, even the hard to make ones and they fit; backed up by toll free installation support.
- Extensive Parts selection with mail order world-wide.
- Sensible mechanical and performance upgrades.
- We also work with many other European marques.



BASSETT'S

PO Box 245 Wyoming, Rhode Island 02898, USA
 Tel: +1-401-539-3010 • E-mail: jagwillie@bassettsinc.com
www.bassettsinc.com

SINCE 1973



**COMPLETE JAGUAR PARTS COVERAGE
 SIX MODEL-SPECIFIC WORLD-CLASS
 CATALOGS NOW ON A SINGLE CD**

*Get Your Jaguar Parts Directly From THE Source...
 Suppliers For Modern And Classic Jags Worldwide - Since 1973*



**WE DO CHARGE FOR PRINT CATALOGS, VISIT THE WEB SITE FOR DETAILS
 ORDER A SINGLE CD AND PRINT ANY OR ALL OF THE PAGES YOU NEED**

*Coverage From 1948-On. Same-Day Domestic And International Shipping,
 Industry Leading Catalogs & Website. Manufacturer For 1000s Of Jaguar Parts*

**XKs Unlimited is Pleased To Support Your Jaguar Club Activities And Offer A Discount To Club Members
 International Calls: +1-805-544-7864 • North American Calls: 800-444-5247
 FAX Direct: +1-805-544-1664 • Email: parts@xks.com**



MOTORCAR SERVICE

*Fine Automobile Service & Restoration
Jaguar Specialists*

- * Routine service to full diagnostics and rebuilds of all British and European late model cars
- * Minor project work to full concours-winning restorations
- * Safe, clean and dry storage
- * Consignment sales of collectible cars
- * Performance improvements for street use
- * Full race preparation, track support and transport of all foreign and domestic vintage cars

Home of the Jaguar Racing XKEs

4 Holmes Road
Lenox, MA 01240

Tel. (413) 499-6000
Fax (413) 499-6699

www.donovanmotorcars.com
info@donovanmotorcar.com



We Specialize In
XKE • XJ6 • XJS Parts

- New • Used
- Remanufactured

Also Give Us a Call
For Your Vintage
Racing Needs

Terry's Jaguar Parts

5850 Stadium Drive
Kalamazoo, MI 49009

For information & catalog:
Call 800-851-9438 or Fax 618-438-2371

On the web at
www.terrysjag.com



SALES * SERVICE * RESTORATION

MOTORCARS
INCORPORATED

333 Cooke Street * Plainville, CT 06062

2010 Jaguar XK PORTFOLIO Edition Convertible

This one owner Roadster is still as like new as it gets. With a 5.0 Litre V8 sit back, hang on and enjoy the ride. And with only 39k miles, it truly drives like a dream. Asking \$39,500.

**Motorcars Incorporated. Jaguar Sales, Service, and Restoration since 1977. 800-899-1055
For multiple pictures and other inventory: www.motorcarsinc.com.**

Classified Ads

Dates in parentheses indicate the issue in which the ad first appeared. Classifieds are also available on our website at www.j-a-n-e.org, where they are updated as they come in, so check there often for new arrivals! Classified ads are free for JANE members and \$15 per insertion for non-members. All ads will expire after three issues unless renewed!

You can easily place, change, renew, or remove your ad online at the JANE website! Or contact Carl Hanson, 40 Springs Road, Bedford, MA 01730, phone **781-275-2707**, or E-mail chansonjag@aol.com. Send text and photos via email, or by mail for free scanning service. Non-members may make checks payable to "JANE, Ltd." at the address above or remit via PayPal to sales@jcna.com.

Got something to sell? Put an ad in this space! JANE members get free classified ads, and rates are reasonable for non-JANE members (see above).

Cars For Sale



1973 Series III-E-Type OTS - 5.3L, same owner for 20 years, beautiful paint & interior, 2001, 2012, just had major service in 2015 by Brookline Jaguar, all awards, maintenance records available, specific manuals, charts, diagrams, etc. go with car. Asking \$100,000. Location: Brookline, MA. Ad placed by Sanda O'Brien. Email: sanda.obrien@comcast.net. Phone: 617-899-5070. (8/15)



1969 XKE 2+2 Series 2 Coupe - 43,180 original miles, 4.2 Liter, autotransmission, factory AC, British Racing Green, original black leather interior, near original, rust-free, 42,991 original miles at restoration. Location: Beverly, MA. Ad placed by Rich Doucette. Email: rdoucette@thebostoncup.com. Phone: 617-834-3937. (3/16)



1999 XK8 - 28K Miles; \$19,500 or BO. All original Jaguar equipment including a burlwood dashboard. Showroom condition with special features like seat piping and a custom made cover for the roof that makes the vehicle look like a "Bat Mobile"! No accidents, second owner, non-smoker, garage kept, never seen snow or salt and seldom rain. The seller will ship at no cost but only to the New England states. Please

call or email today for more details. Ad placed by Les Ball. Email: lesballscituate@gmail.com Phone: 781-378-2002. (4/16-6/16)

Parts For Sale

CLASSIC JAGUAR PARTS - Buying and selling Jaguar parts for XKs, E-Types, and Saloon models. Please contact John Brady (781-454-9706, jbrady5282@aol.com) or Tom Brady (617-901-6988, tbrady312@aol.com) for our current parts/price list or if you are interested in selling parts or tools. Interested in large and small lots. Located in Bedford and Brockton, MA. (8/09)

Set of 4 Winter Wheels & Tires - XJR 2004 4 Winter HanKook Icebear 245/45 R 18 100R tires mounted on Tire Rack chrome wheels purchased with 2004 Jaguar XJR + 20 flat lugnuts - STILL FOR SALE!! REDUCED TO MOVE!! Location: Wayside Inn Road, Framingham, MA 01701; Price: \$350 obo. Ad placed by Richard D Gill. Phone: 508-788-0026. E-Mail: RIK14455@aol.com. (1/09)

Steering wheel for E-Type, 13.5 inch diameter. Complete for installation, smaller than standard wheel allowing for more room in cockpit. Asking \$150 OBO Ad placed by Allen Liberman. Phone 617-817-5012. Email libs999@hotmail.com. Located in Newton, MA. (3/13)

Cars/Parts Wanted

Car Wanted: E-type & XK's - Running or Not. I am looking for XKE's and XK's in any condition. Will travel. Please call or email me at 617-838-3728. Ad placed by R. Crook. Phone: 617-838-3728. Email: crookjag@comcast.net. (9/13)

Miscellaneous



Women's "Jaguar Essence" Silk Scarf - This scarf makes a wonderful gift for a lady Jaguar lover's birthday, anniversary, holiday, etc. Purchase includes wrapping in heavy-weight gold striped tissue paper and secured with a Scarfsense gold foil seal. Order online at <http://scarfsense.com/collection/jaguar-essence>. Call me should you have any questions. Location: National Delivery. \$67.95. Ad placed by Kathy Gorbach. Phone: 508-277-2737. Email: kgorbach@yahoo.com. (4/12)

JAGUAR COLLECTIBLES - I Buy, Sell and Trade Jaguar Toys, Models, DieCast, Posters, Manuals, Books, Brochures, EJAG Mag...more and much more. Location: Southampton, New York. Visit us on eBay as XK140CAT Ad placed by S. Ring. Phone: 631-259-2604. Email: basicnyc@aol.com. (9/13)

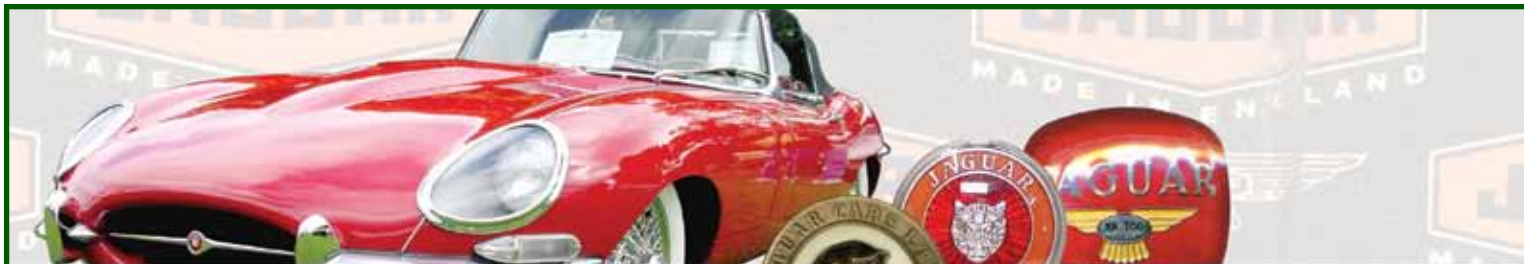

WELSH

ENTERPRISES, INC.

1-800-875-5247 | www.welshent.com

The largest independent retailer of new, used & rebuilt Jaguar spares since 1965

- New Parts
- Used Parts
- Rebuilt Parts
- 100,000 sq ft facility
- Orders placed before 3 pm ship that day

Proud supporter of the JCNA



WWW.JCTAYLOR.COM

1-888-ANTIQUE



INSURING YOUR VEHICLES FOR OVER 50 YEARS

UNPARALLELED CLAIMS SERVICE

AGREED VALUE COVERAGE

EASE OF DOING BUSINESS



facebook.com/jctaylorinsurance

PROUD SUPPORTER OF THE JAGUAR ASSOCIATION OF NEW ENGLAND

PRESERVE THE INTEGRITY OF YOUR CLASSIC JAGUAR WITH
COVENTRY WEST REMANUFACTURED PARTS



INSPIRED BY
EXCELLENCE



DEVOTED TO
SERVICE



2101 Randall Road
Lithonia, GA 30058



We offer custom rebuilding services for engines, cylinder heads, steering racks, transmissions, water pumps and differentials which maintain the value of your classic Jaguar.
TOLL FREE 800-331-2193. WWW.COVENTRYWEST.COM SALES@COVENTRYWEST.COM



BECAUSE BABIES
—need—
SPECIALISTS

Hagerty specializes in collector cars and their adopted parents. Both deserve pampering – care and expertise you won't find in the practices of general insurance companies. Call your local Hagerty agent below for a consultation. The doctor is always in.



MALLARD INSURANCE
Auto • Home • Life • Business

Michael A. Bernier

5 Coliseum Avenue
Suite 303
Nashua, NH 03063

603.943.7257
F 603.943.7259
michael@mallardinsurance.com



Classic Car Insurance™

The new classic



Jaguar Peabody
247 Newbury Street
Peabody, MA 01960
www.jaguarpeabody.com



The Coventry Cat

Jaguar Association of New England
329 Ross Corner Rd • Shapleigh, ME 04076

Place
Stamp
Here

Mailing Label

Are your *Investments* on track?

Navigating the sometimes-complex
and volatile financial markets
requires experienced guidance.



Serving uncommonly
successful individuals
for **45** years.

Recognized in the financial industry as a leader and complex
problem solver, Michael Kaleel and his team provide:

- Guidance and leadership designed solely to reach individual objectives.
- A sophisticated investment approach designed to help mitigate the potential impact of risks and taxes.
- Ongoing planning, strategy and communication to help you stay on track to meet your immediate and long-term lifestyle needs.



The Kaleel Company, Inc.

77 Franklin Street, Suite 501
Boston, MA 02110
617.338.8747
info@kaleelcompany.com
www.kaleelcompany.com